



PRATIKO



PRATIKO

LA PROGETTUALITÀ 'INFINITA'

'INFINITE' DESIGN

Una straordinaria flessibilità.
Che consente di ripensare
e riconfigurare lo spazio.
In virtù del principio di libertà
e di apertura che anima
il pensiero di ogni progetto.

Extraordinarily flexible.
Re-create and re-configure space.
Complete freedom animating
the heart of every design.

sistema
OPERATIVO
INTEGRATO



PRATiKO

LE SCRIVANIE

THE DESKS





Anche in ufficio
LESS IS MORE



A SOUL THAT IS VERSATILE

Elementi dal carattere versatile



sistema
OPERATIVO
INTEGRATO





Una straordinaria flessibilità

EXTRAORDINARILY FLEXIBLE



Elementi dal carattere aperto



A SOUL THAT IS OPEN





PRATI*KO*
IL SISTEMA

A SOUL THAT IS CONCRETE

Elementi
dal carattere
concreto

sistema
OPERATIVO
INTEGRATO

PRATIKO

IL PONTE DOPPIO



Elementi
dal carattere
rigoroso

A SOUL THAT IS CONCRETE







Elementi dal carattere concreto

A SOUL THAT IS CONCRETE

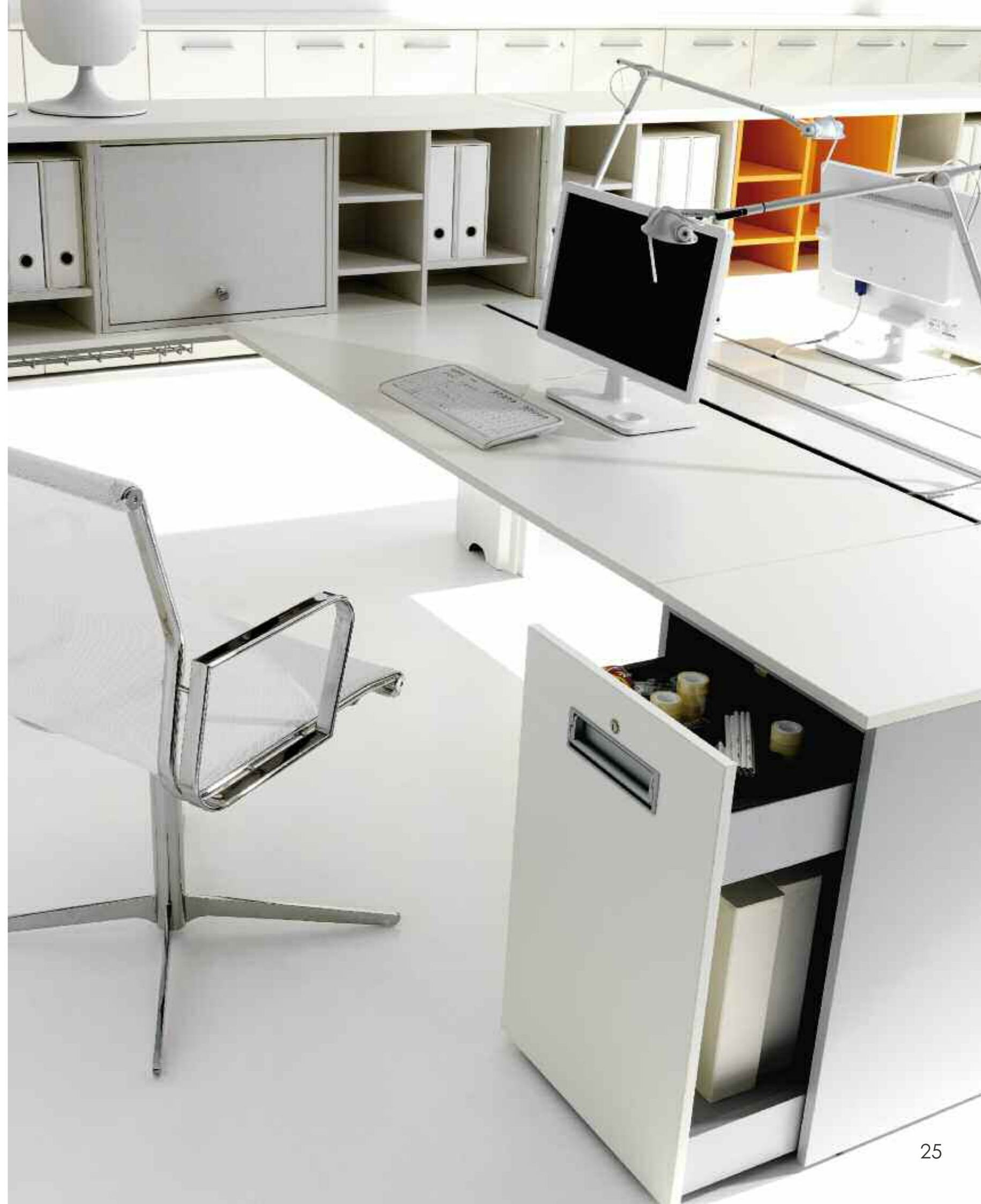



PRATIko

ILLUMINAZIONE LED

LED LIGHTING



Anche in ufficio
LESS IS MORE





EXTRAORDINARILY FLEXIBLE

Una straordinaria flessibilità



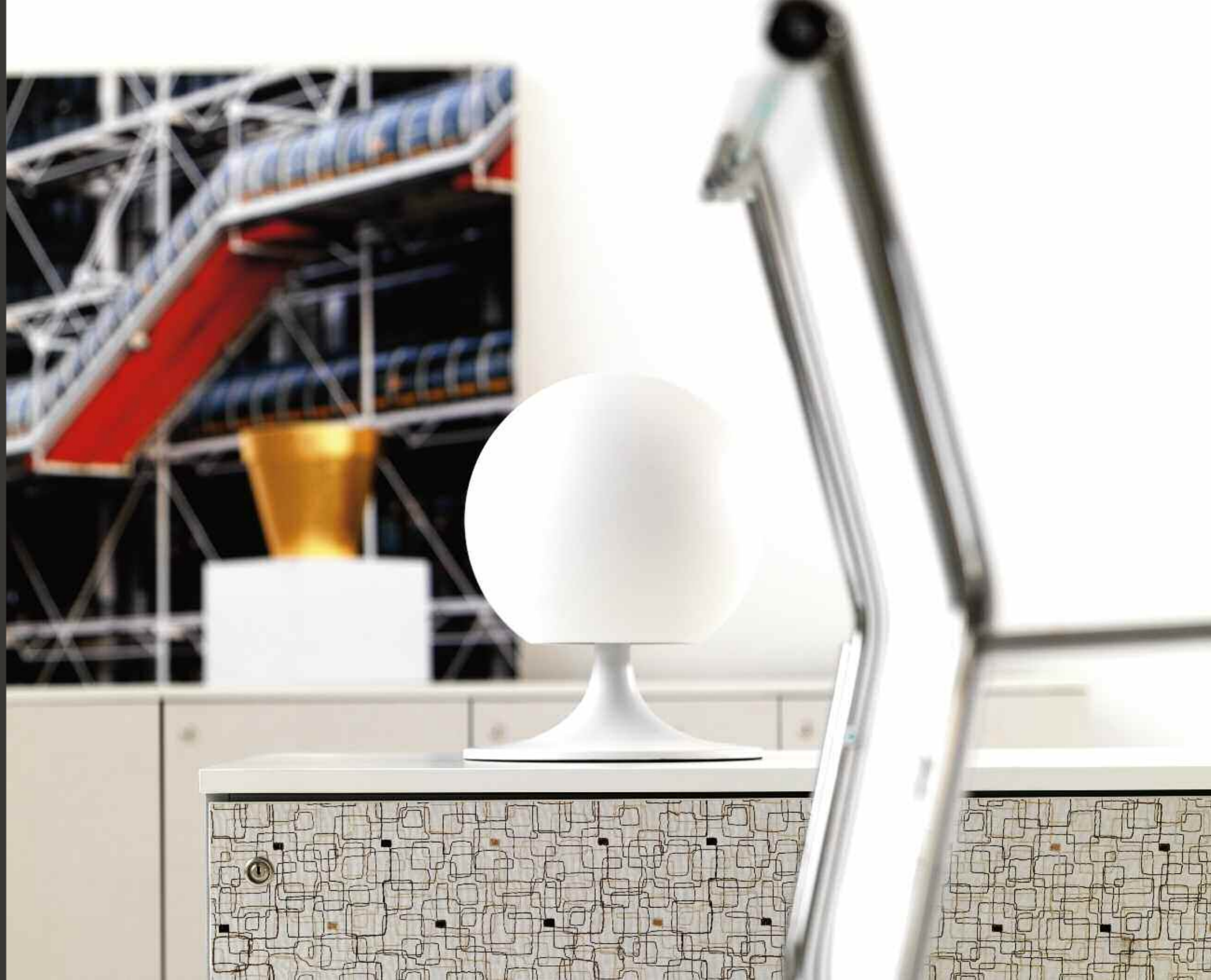



A TRANSVERSAL DESIGN

Un progetto trasversale

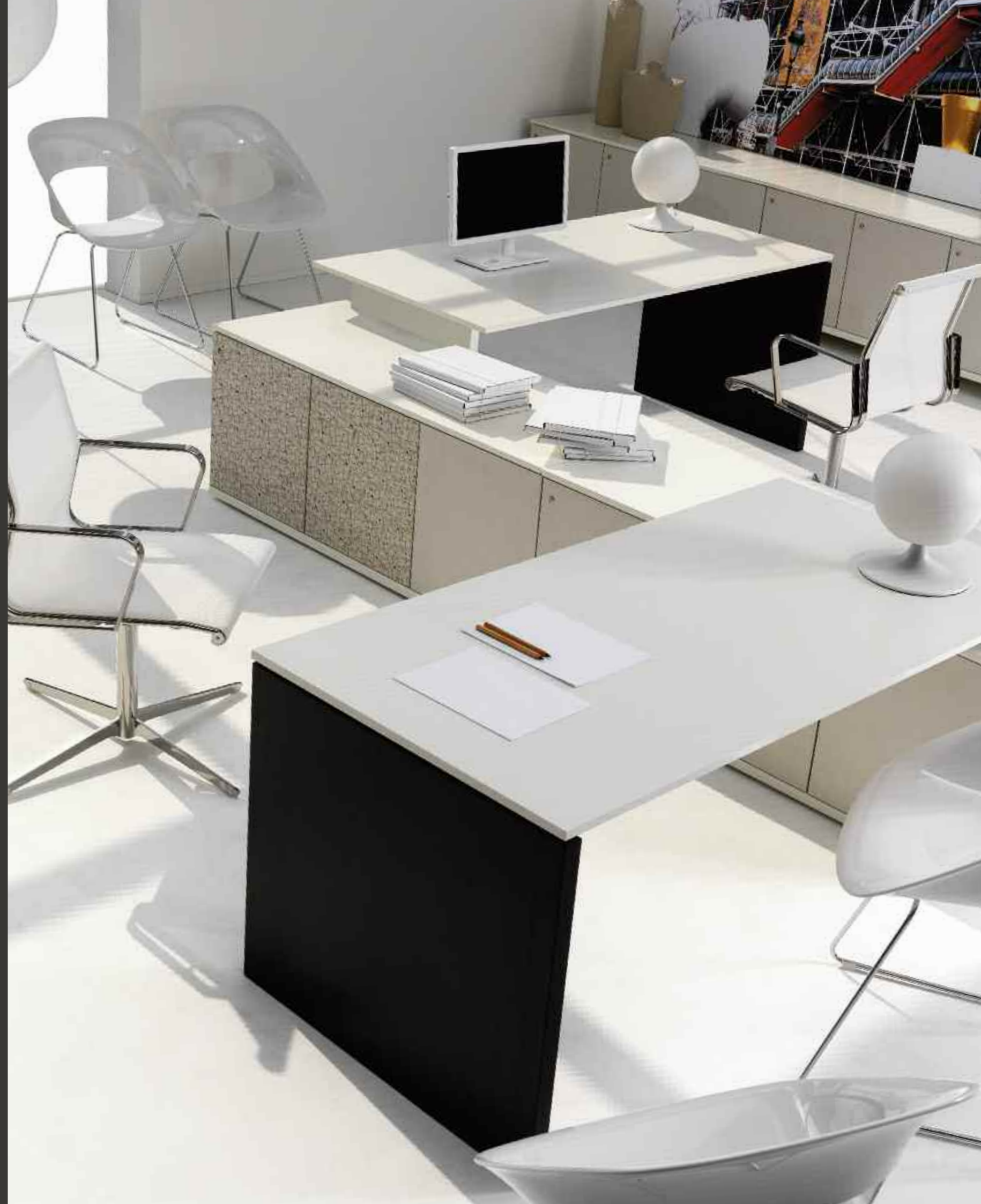





Elementi di carattere



La tecnologia



3 Livelli di attrezzabilità

3 SURFACE FITTINGS OPTIONS



ST _ Standard

La soluzione **Standard** prevede il fissaggio di screen, lampade e portamonitor con appositi supporti metallici posizionabili nello spazio presente tra i due piani. L'accesso dei cavi ai piani può essere risolto dal foro+boccola oppure utilizzando lo spazio presente tra i due piani.

ST _ Standard

*The **Standard** version enables screens, lamps and monitor shelves to be attached by means of special metal mounts positioned in the space between the two tops.*

Cables pass through to the desktop by means of a hole plus cable grommet or the space between the two levels.



BN _ Con binario attrezzabile

La variante BN consente di fissare, attraverso il binario centrale, screen, lampade e portamonitor. L'accesso dei cavi ai piani viene garantito da un semplice "foro+boccola per passaggio cavi".

BN _ With accessory bar

The BN model is equipped with a central track to attach screens, lamps and monitor shelves. Cables pass through to the desktop by means of a simple hole plus cable grommet.



FT _ Con binario attrezzabile e canalizzazione ispezionabile direttamente dal piano

La fascia tecnica superiore, oltre a garantire una perfetta gestione del wire_management, "organizza" al meglio anche lo spazio del piano. Il binario centrale infatti, oltre al posizionamento dello screen, permette di fissare direttamente al piano stesso lampade e portamonitor.

FT _ With accessory bar and cable management area directly accessible from the desktop

The cable management tray in the desk top guarantees perfect wire management and also efficiently organises desk top space.

As well as for positioning screens, the track also enables lamps and monitor shelves to be attached directly.



Nobilitato Penelope
Melamine

Arancio
Orange

Lilla
Lilac

Verde
Green

Sabbia
Sand

Argilla
Clay



Tessuto Decoro
Decorative Fabric



Nobilitato Melamine

Alluminio
Aluminium

Avorio
Ivory

Rovere Sbiancato
Whitewashed oak

Noce Canaletto
Canaletto walnut

Wengè
Wengé



Cristallo Laccato
Lacquered Glass

Moka
Moka

Nero
Black

Blu
Blue

Extralight Bianco
White Extralight

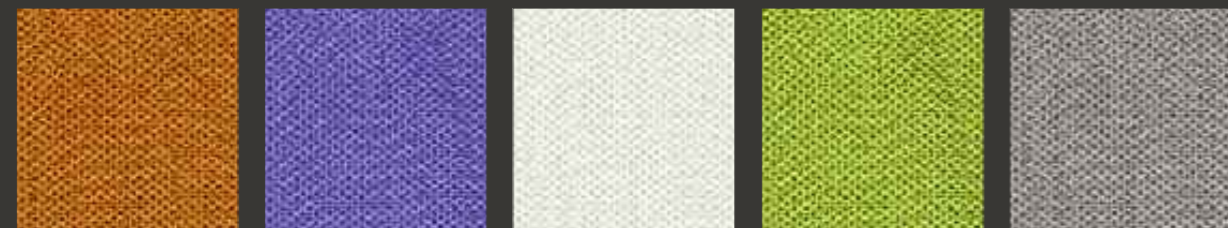

Tessuto
Fabric

Arancio/Orange
code SLL E

Blu/Blue
code SLL H

Bianco/White
code SLL F

Verde/Green
code SLL D

Grigio/Grey
code SLL G



Metallo
Metal

9010 Bianco
9010 White

9006 Alluminio
9006 Aluminium

IVM libera tutti

_SCRIVANIE LINEARI P.80

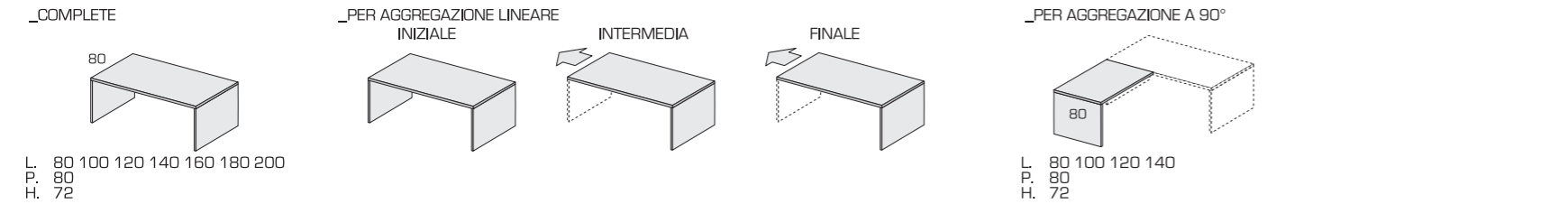

_SCRIVANIE LINEARI P.60

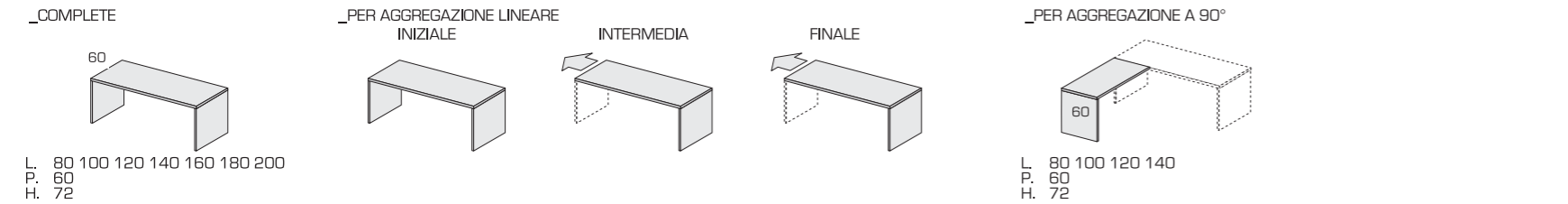

_SCRIVANIE DOPPIE P165

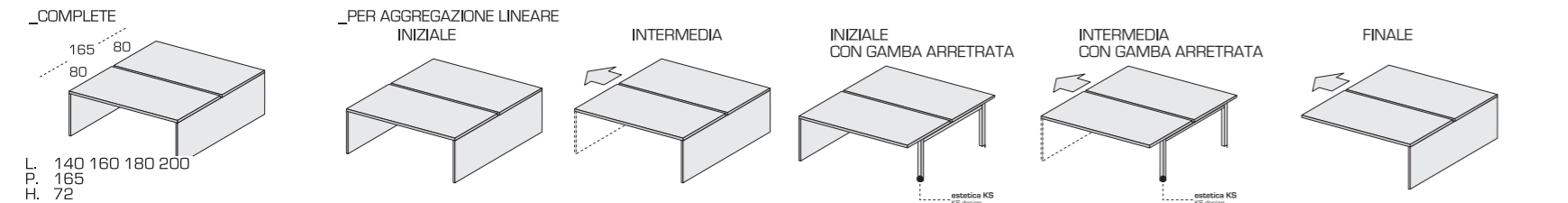

_SCRIVANIE LINEARI DOPPIE P.125

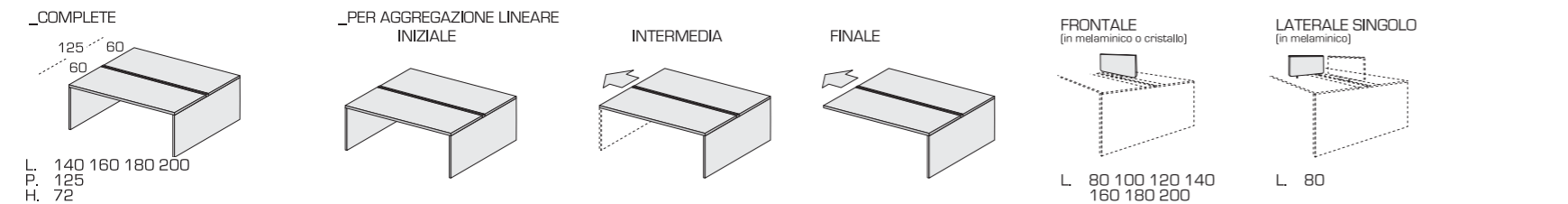

_SCRIVANIE LINEARI P.80 con vano

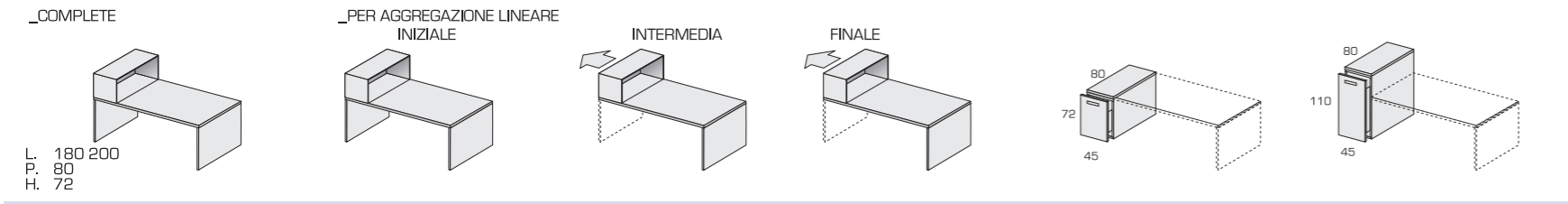

_SCRIVANIE LINEARI DOPPIE P.165 con vano

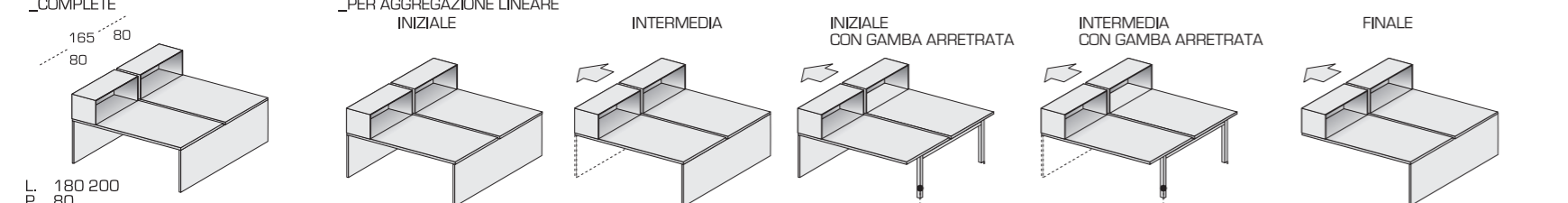

_PONTE h.119 singolo

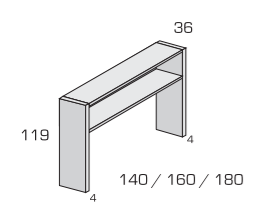

_PONTE h.119 doppio

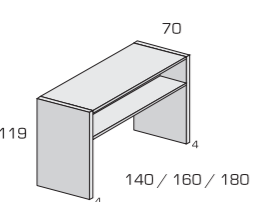

_PONTE h.64 doppio

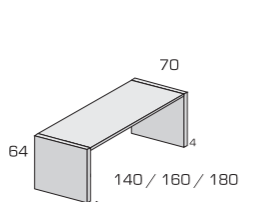

_ACCESSORI per ponte

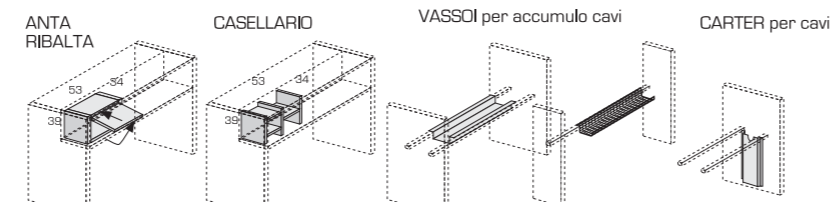

_PIANI per PONTE

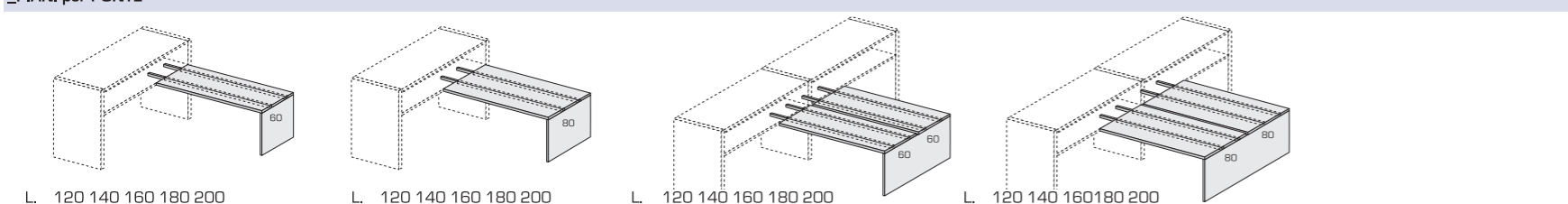

_COMPACT WORK STATION

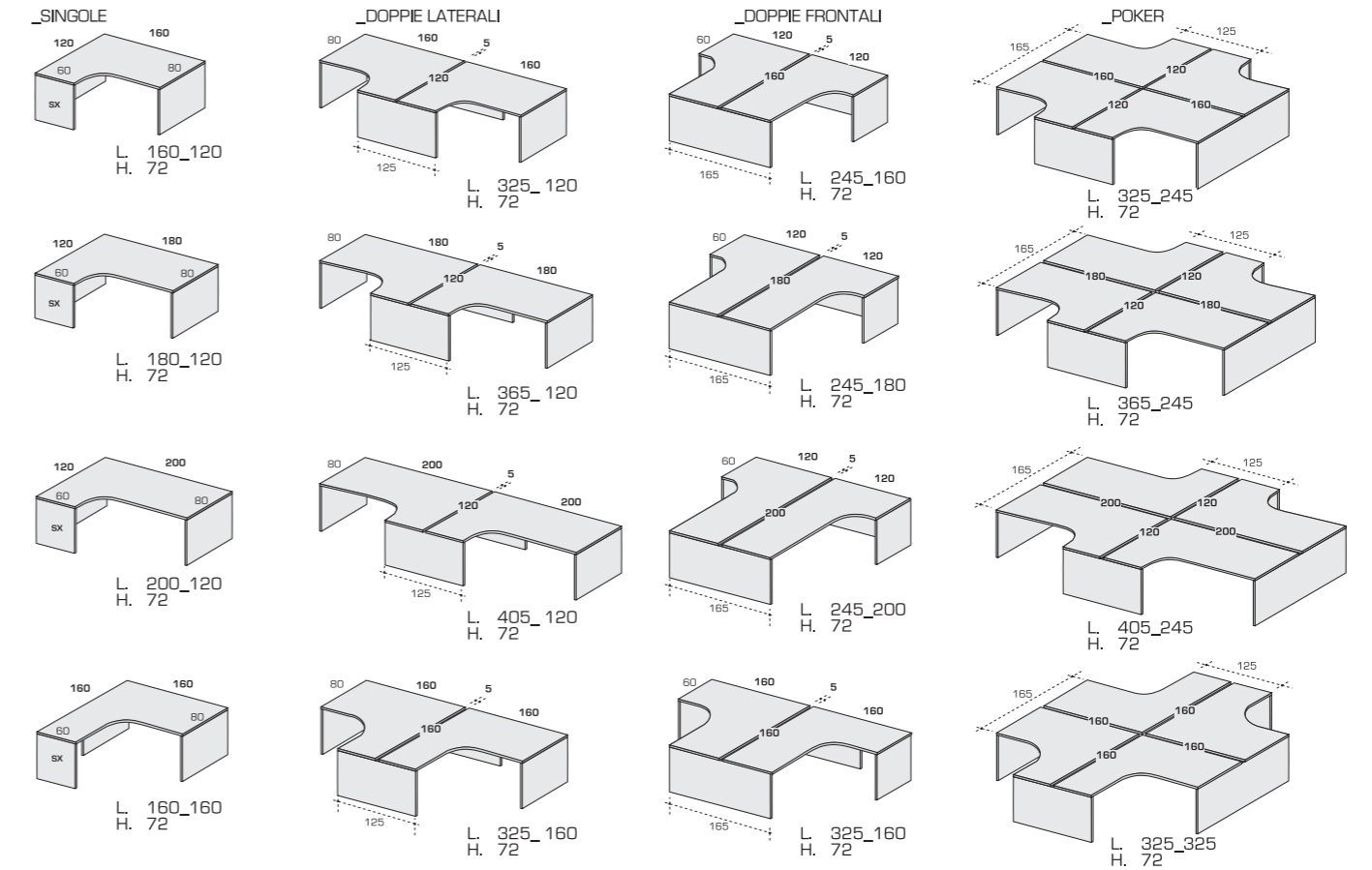

_COMPACT WORK STATION CON ELEMENTO VANO

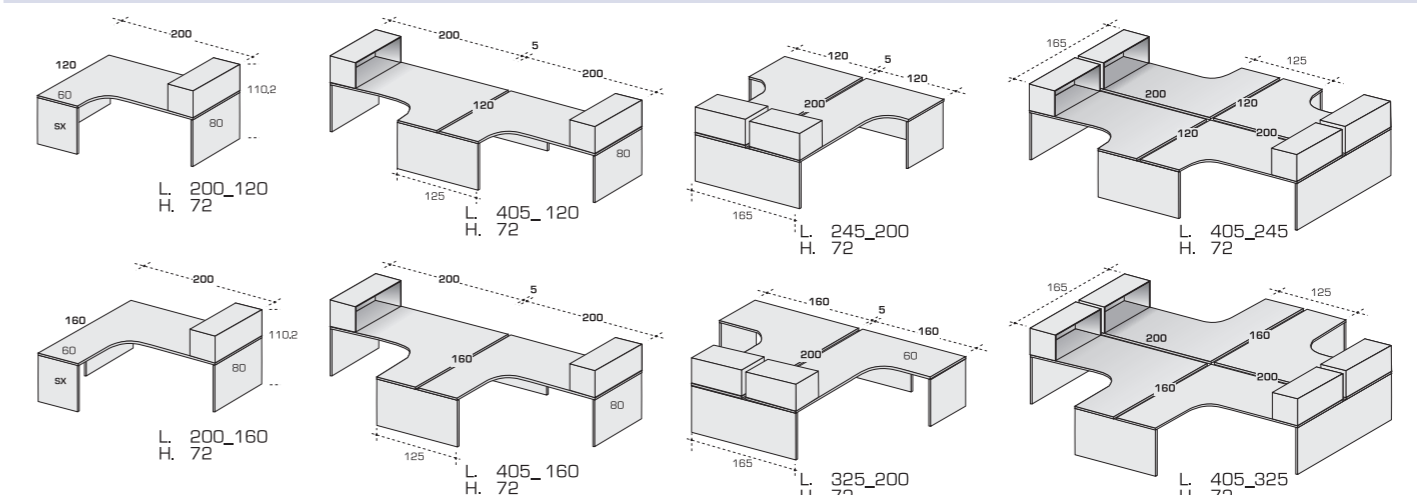

_MODULI CONTENITORI P.46.5

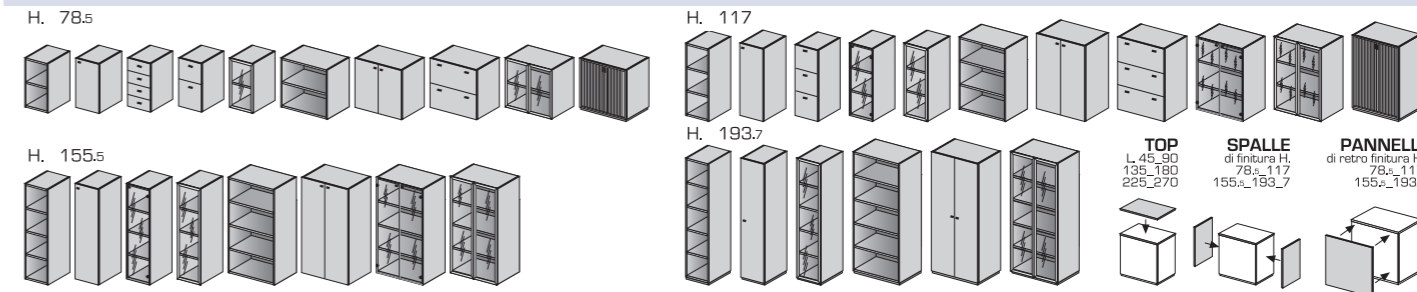

_MODULI CONTENITORI P.36.5

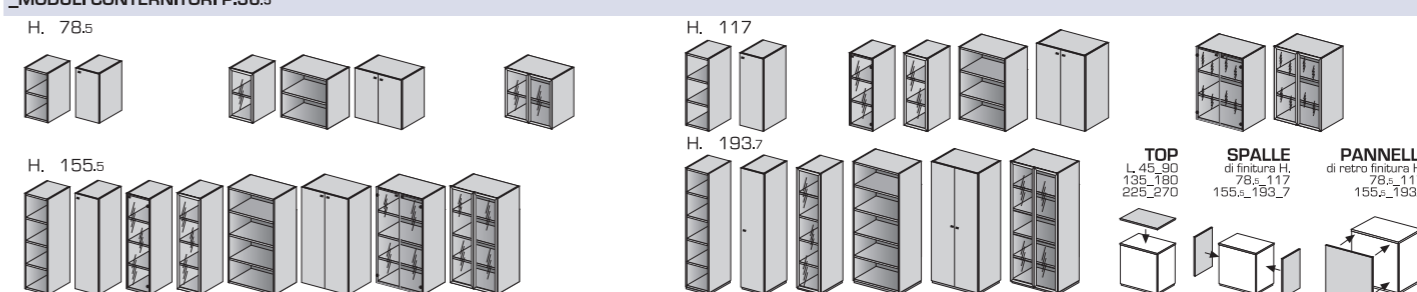

_PENISOLA

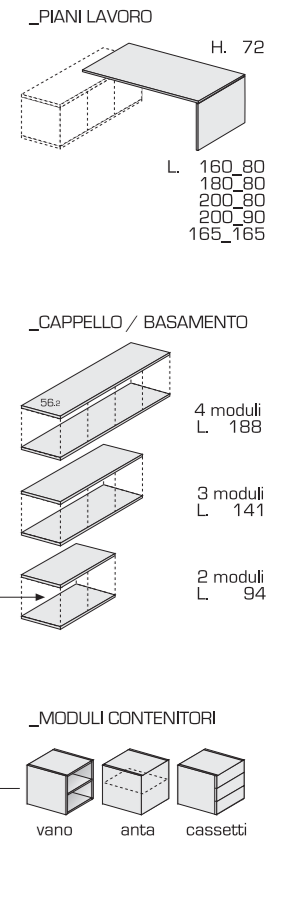

_SISTEMA RECEPTION

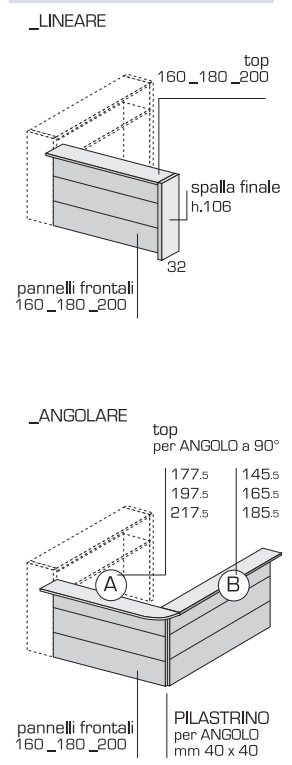

_CONTENITORI in metallo

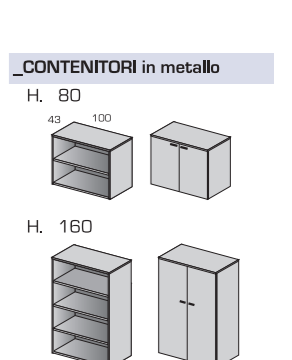

Ricordiamo che:

IVM utilizza per l'80% della sua produzione pannelli prodotti con legno vergine di provenienza certificata.

Questo significa maggiore tenuta di viti, cerniere, giunti; maggiore resistenza al peso e agli urti; maggiore resistenza all'usura del tempo.

IVM utilizza pannelli dotati di certificazione ambientale **FSC** (Forest Steward Council) secondo il sistema di Qualità Vision 2000. Il marchio FSC identifica i prodotti contenenti legno proveniente da **foreste certificate**, cioè gestite in modo corretto e responsabile secondo rigorosi standard ambientali, sociali ed economici.

Qualità di prodotto e tutela dell'ambiente.
Un progetto in costante crescita.

Remember:

IVM uses virgin wood panels with a certified origin in 80% of its products. It means providing a greater grip for screws, hinges, and joints, which have improved resistance to weight, knocks and become more long-lasting.

IVM uses panels with **FSC** (Forest Stewardship Council) environmental certification, in accordance with the Vision 2000 quality system. The FSC brand identifies products containing wood from **certified forests**, that is, forests managed in a correct and responsible manner, in line with rigorous environmental, social and economic standards.

Quality products and protecting the Environment.
A project seeing constant growth.

sistema
OPERATIVO
INTEGRATO

Art Direction _Rita Salogni
Progetto Grafico _Rita Salogni
Photo _Stefano Tonicello
Styling _Patrizia Arrigoni
Elaborazione _HiRes
Fotolito _OverScan
Stampa _Mastergraph
_06/2010

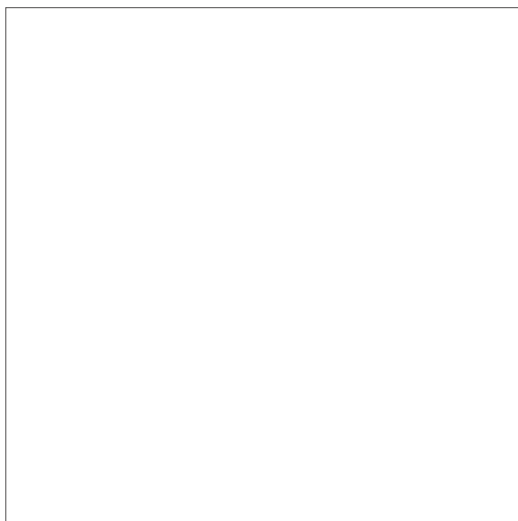

IVM S.p.A
20035 LISSONE (Milano) ITALY
Via C. Cattaneo, 90
<http://www.ivmoffice.it>
e-mail: info@ivmoffice.it
Tel. (+39) 039 2443.1
Fax (+39) 039 2443 250/252/253